

LONG DISTANCE COMMUNICATION BY FIBER OPTICS USING SOLITARY WAVE

M.Bala Krishna¹, S.B.G.Sagar²

¹Assistant Professor, ²UG Student, Dept. of ECE, G.M.R. Institute of Technology, (India)

ABSTRACT

Multiterabit/s, ultrahigh-speed optical transmissions over several thousands of kilometers on fibers are becoming reality. The group velocity dispersion (GVD) imposes severe limit on information carrying capacity of optical communication systems. By choosing appropriate pulse shape highly stable light pulses known as solitons are generated when effect of GVD is balanced by self-phase modulation (SPM). The application of solitons in communication systems opens the way to ultrahigh-speed information superhighways. Transmission speed of order of Tbit/s can be achieved if optical amplifiers are combined with WDM in soliton based communication systems. The simulation results for Soliton order $N=1$ and $N=3$ are obtained using OptSim Software.

Keywords: Dispersion, GVD, Soliton pulses, SPM.

I. INTRODUCTION

The need of communication is an all-time need of human beings. For communication some channel is needed. Fiber is one channel among many other channels for communication. Optical Fibers are thin long strands of ultra-pure glass or plastic that can transmit light from one end to another without much attenuation or loss. Fiber optic systems transmit using infrared light, invisible to the human eye, because it goes further in the optical fiber at those wavelengths. Figure 2 shows the windows use by optical fiber communication.



Fig.1: Light Used In Fiber Optics

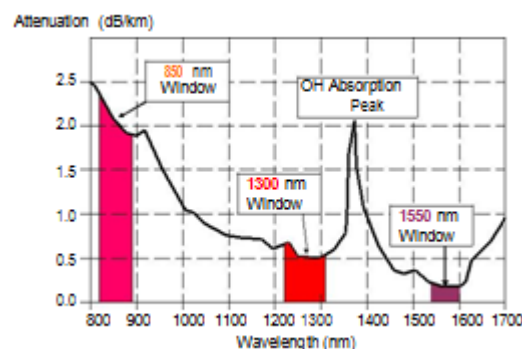

Fig.2. Optical fiber windows

A. Advantages of optical fiber Communication

- Long distance transmission due to low attenuation (order of 0.2 db/km) thereby reducing number of repeaters (cost & complexity).
- Large information capacity due to wider bandwidth.
- Small size & low weight resulting in ease of installation.
- Immunity to electrical interference because of dielectric material.
- Enhanced safety since they do not have ground loops sparks, etc. However, laser light can damage eye.
- Increased signal security since the optical signal is well confined within the fiber.
- Low cost as compared to copper (as glass is made from sand. The raw material used to make of is free....)
- Zero resale value (so theft is less)

B. Disadvantages of optical fiber Communication

- OFC is delicate so has to be handled carefully.
- Communication is not totally in optical domain, so repeated electric -optical -electrical conversion is needed.
- Optical amplifiers, splitters, MUX-DEMUX are still in development stages.

C. Dispersion Phenomenon

Dispersion represents a broad class of phenomena related to the fact that the velocity of the electromagnetic wave depends on the wavelength. In telecommunication the term of dispersion is used to describe the processes which cause that the signal carried by the electromagnetic wave and propagating in an optical fiber is degraded as a result of the dispersion phenomena. This degradation occurs because the different components of radiation having different frequencies propagate with different velocities.

Dispersion types are

1. Mode dispersion
2. Chromatic dispersion
 - Waveguide dispersion (optical)
 - Material dispersion.(Group velocity, group velocity dispersion GVD)
 - Polarization dispersion

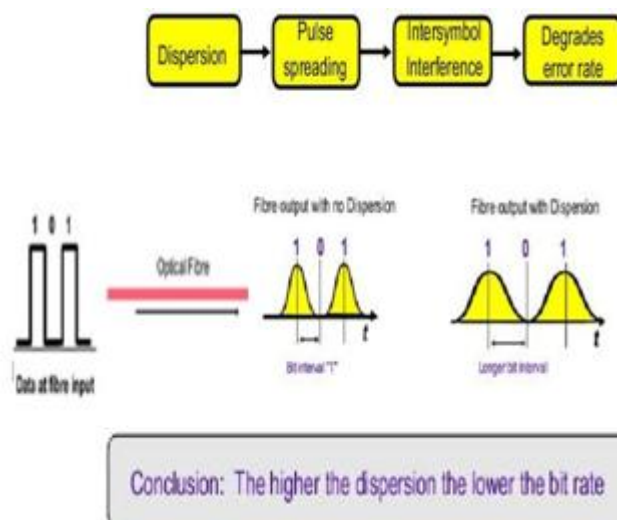

Fig.3: Dispersion in optical fiber

The dispersion phenomenon is a problem for high bit rate and long haul optical communication systems. An easy

solution of this problem is optical solitons—pulses that preserve their shape over long distances. Soliton based optical communication systems can be used over distances of several thousands of kilometers with huge information carrying capacity by using optical amplifiers. The application of solitons in communication systems opens the way to ultrahigh-speed information superhighways[3]. Transmission speed of order of T bit/s can be achieved if optical amplifiers are combined with WDM in soliton based communication systems.

II. SOLITON BASED TRANSMISSION

Soliton [6-10] term refers to the special kinds of waves that can propagate undistorted over long distances and remain unaffected after collisions with each other.

- Generally when one pulse is designated to represent ‘1’ digit, the format is called RZ (Return to Zero).
- On the other hand if two (or more) pulses are connected when a sequence of ‘1’ appears, the format is called NRZ (Not Return to Zero).
- In addition, if the ‘1’ pulse is allowed to have two type of pulses with opposite phases; these format is called duo-binary.
- Soliton format primarily uses one soliton to represent ‘1’ digit
- These formats are illustrated below.

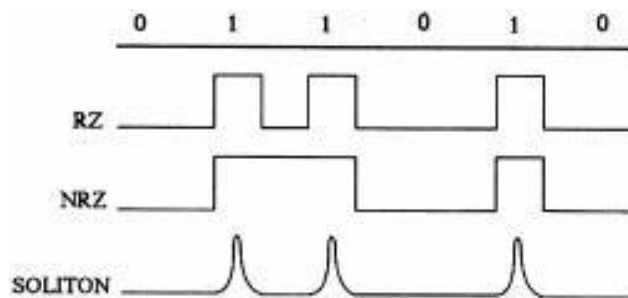

Fig.4: Various modulation formats for information transfer in fibers [4]

A. Information Transmission

A digital bit stream can be generated by two distinct modulation formats i.e., non-return-to-zero (NRZ) and return-to-zero (RZ). The solution of NLS equation for soliton holds only when individual pulses are well separated. This can be ensured by keeping soliton width a small fraction of the bit slot. To achieve this, RZ format (Figure 5) has to be used instead of NRZ format when solitons are used as information bits.

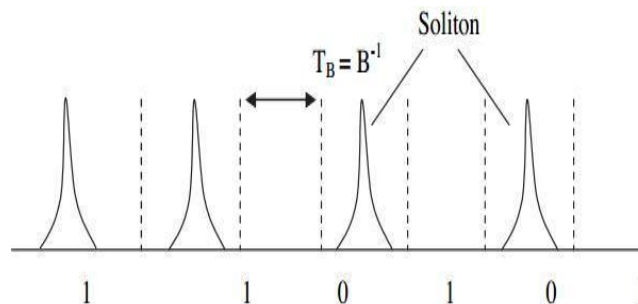

Fig.5. Soliton bit stream in an RZ format

The bit rate B and the width of the bit slot T_B can be related as

$$B=1/T_B=1/2S_0T_0.....(1)$$

Where $2S_0=TB/T_0$ is the normalized separation between neighbouring solitons.

B. Soliton in Optical Fiber

The purpose of this example is to demonstrate the propagation of soliton pulse in optical fiber. The existence of solitons in optical fibers is the result of a balance between the chirps induced by fiber dispersion characterized by GVD (Group-Velocity Dispersion) coefficient β_2 and fiber nonlinearity characterized by SPM (self-phase modulation) coefficient γ . Analytically soliton is a solution of nonlinear Schrodinger equation describing pulse propagation in optical fiber and can be derived as[5]:

$$A(z,t)=N \text{Sech}(t/T_0)\exp(J\pi z/4z_0)\sqrt{P_0}.....(2)$$

where P_0 - soliton peak power, T_0 - pulse width, Z_0 - soliton period, N - soliton order. Soliton period defined as

$$Z_0=\pi(T_0)^2/2(\beta_2).....(3)$$

The optical pulse which corresponds to $N=1$ is called fundamental soliton. Pulses with $N>1$ are called higher-order solitons. Soliton order parameter N depends on the balance between dispersion and nonlinearity and is defined as:

$$N^2=\gamma P_0(T_0)^2/(\beta_2).....(4)$$

The layout for generation of the solitons is shown in Figure 6. It consists of pulse generator (mode-locked laser), single-mode lossless fiber, and waveform and spectrum analyzers. The fiber is assumed to be lossless to demonstrate ideal soliton propagation.

III. SIMULATION AND RESULTS

Figure 6 shows the layout for fundamental soliton $N=1$ and its simplified block diagram is shown in fig.7. The simulation is done in OptSim software. For given $n_2=2.6e-20$ m²/W, $A_{eff}=60$ um², and $\lambda=1550$ nm - $\gamma=1.75e-3$ 1/m/W. The fiber length is set to one soliton period, which for given parameters is $Z_0= 27.525$ km. Initial pulse has a sech shape and FWHM pulse width is 33 ps, corresponding to $T_0=18.7$ ps. Pulse power for fundamental soliton is 32.7 mW and for 3rd order soliton 293.4 mW. Figures 8 to 12 shows soliton pulse evolution (in time and frequency domains) in fiber along one soliton period for $N=1$ and Figures 14 to 18 show soliton pulse evolution (in time and frequency domains) in fiber along one soliton period for $N=3$. By comparing the input and output figures we can say that soliton pulse shapes are exactly same after 27.525Km distances.

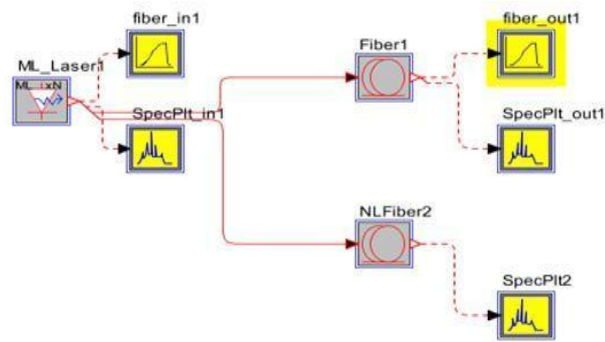

Fig.6:Layout for soliton, N=1

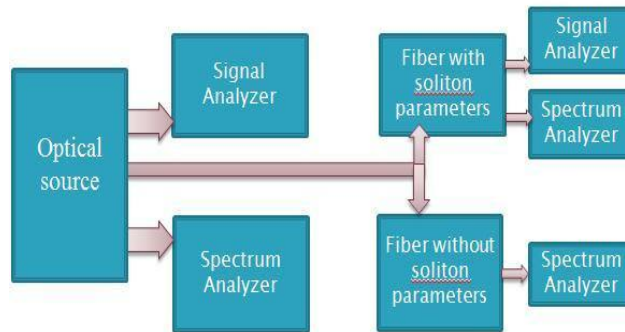

Fig.7: Simplified Block diagram of Layout for soliton, N=1

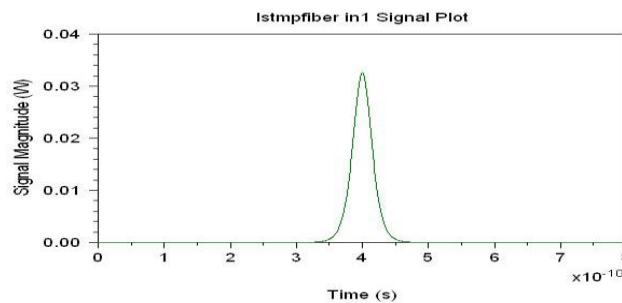

Fig.8: Input signal in time domain (N=1)

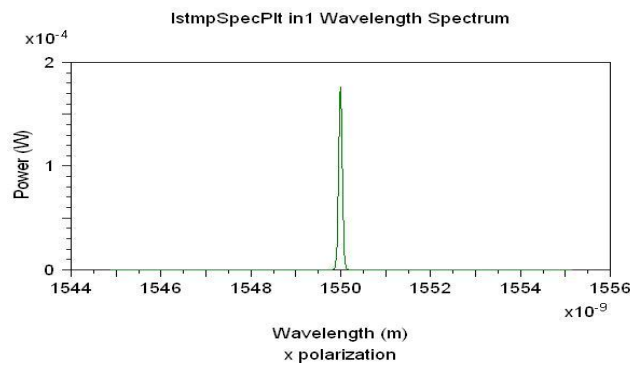

Fig.9: Input signal in frequency domain (N=1)

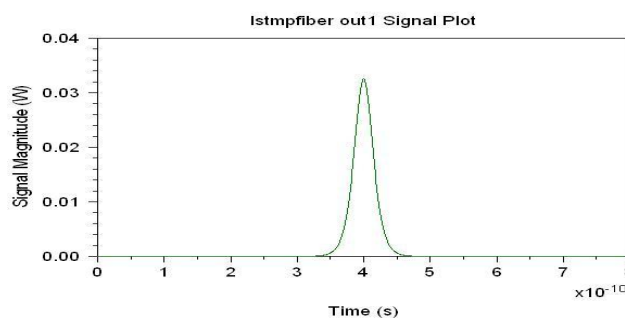

Fig.10: Output signal in time domain (N=1)

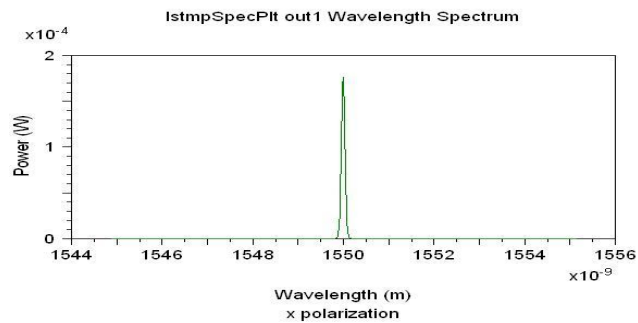

Fig.11: output signal in frequency domain (N=1)

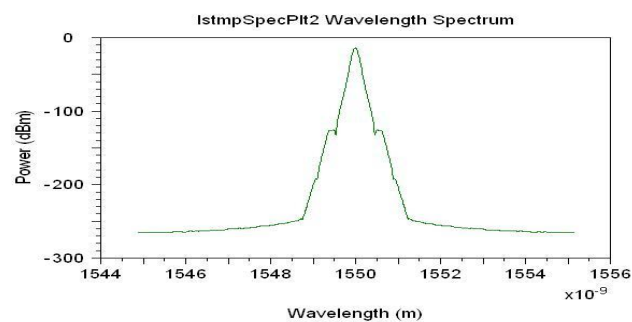

Fig.12: Output signal in frequency domain (without soliton parameter) (N=1)

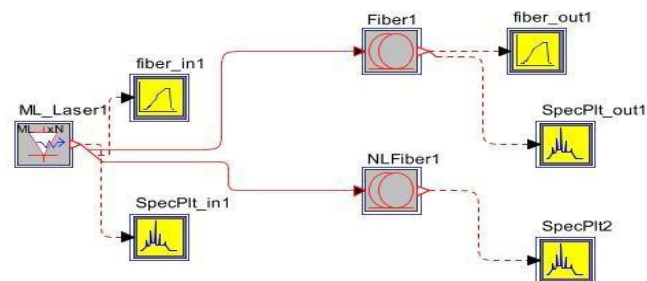

Fig.13:Layout for soliton, N=3

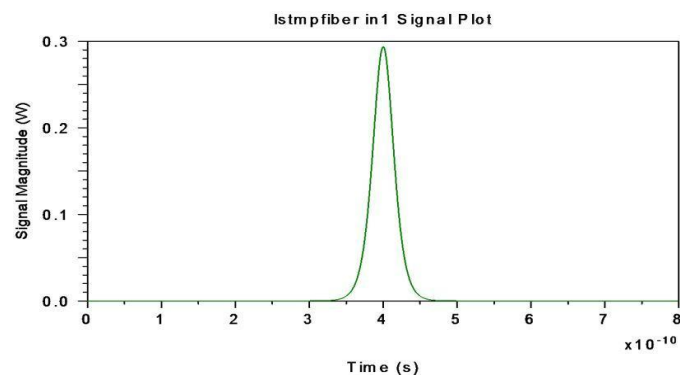

Fig.14: Input signal in time domain (N=3)

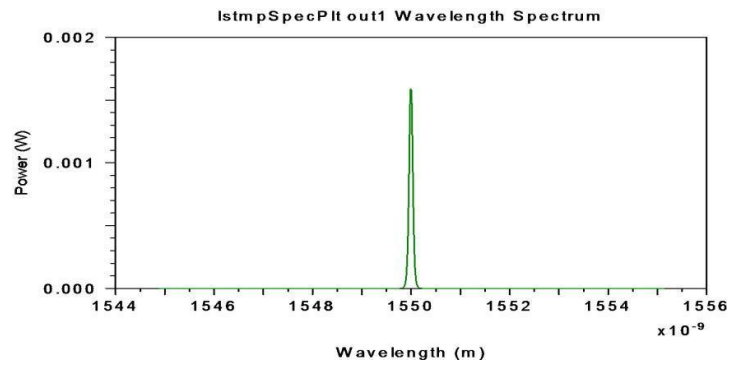

Fig.15: Input signal in frequency domain (N=3)

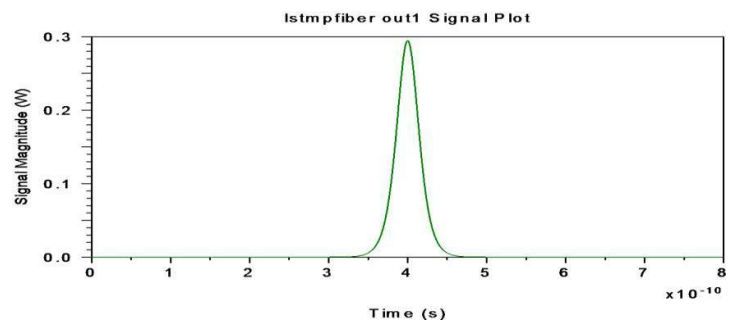

Fig.16: Output signal in time domain (N=3)

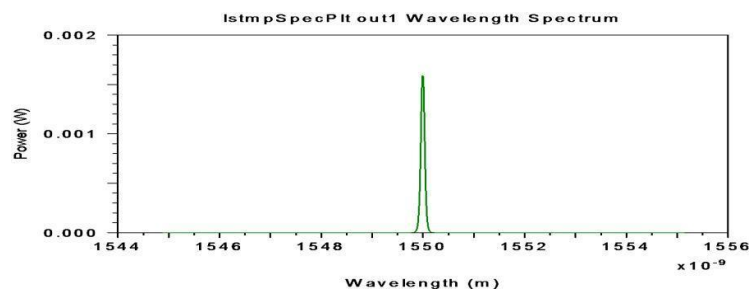

Fig.17: output signal in frequency domain (N=3)

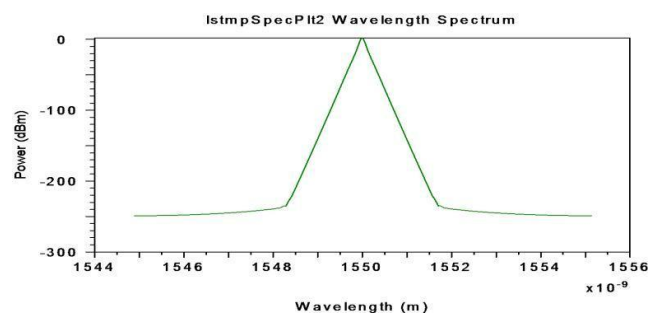

Fig.18: Output signal in frequency domain (without soliton parameter) (N=3)

IV. CONCLUSION

Soliton based optical fiber communication systems are more suitable for long haul communication because of their very high information carrying capacity and repeater less transmission. Soliton pulses do not get affected (by dispersion) after long distance communication. By checking the result of layout for fundamental soliton ($N=1$ & 3 both) we can say that soliton pulses shape having similar shape after travelling 27.525Km distances. For $N=3$ source peak power is increased as compared to $N=1$.

REFERENCES

- [1] Gerd Keiser, Optical Fiber Communications, 4th edition, Tata McGraw-Hill, 2008.
- [2] <http://hank.uoregon.edu>.
- [3] R. Gangwar, S. P. Singh, and N. Singh, "Soliton based optical communication", Progress In Electromagnetics Research, PIER 74, 157–166, 2007.
- [4] Akira Hasegawa, "Soliton-based ultra-high speed optical communications", Vol. 57, Nos 5 & 6-journal of physics Nov. & Dec. 2001.
- [5] Opsim-appnotes.pdf.
- [6] R. Ganapathy, K. Porsezian, A. Hasegawa, Life Fellow, IEEE, and V. N. Serkin, "Soliton Interaction Under Soliton Dispersion Management",
- [7] IEEE journal of quantum electronics, Vol. 44, NO. 4, April 2008.
- [8] David S. Ricketts, Member, IEEE, Xiaofeng Li, Student Member, IEEE, "On the Self-Generation of Electrical Soliton Pulses", IEEE journal of solid-state circuits, Vol. 42, NO. 8, August 2007.
- [9] Yang Jing Wen and Xiang Lin Yang, Senior Member, IEEE, "Quasi-Transform-Limited Pulse Transmission in Dispersion Managed Soliton System", IEEE photonics technology letters, Vol. 11, NO. 4, April 1999.
- [10] Kuppasamy Porsezian, Ramanathan Ganapathy, Akira Hasegawa, Life Fellow, IEEE, and Vladimir N. Serkin, "Nonautonomous Soliton Dispersion Management", IEEE journal of quantum electronics, vol. 45, no. 12, December 2009.
- [11] Hiroyuki Toda, Katsuyuki Mino, Yuji Kodama, Akira Hasegawa, Life Fellow, IEEE, and Peter A. Andrekson, Member, IEEE, Member, OSA, "Influence of Noise in Optical Pulse Source on Soliton Transmission", journal of lightwave technology, vol. 17, no. 6, June 1999.